

PA

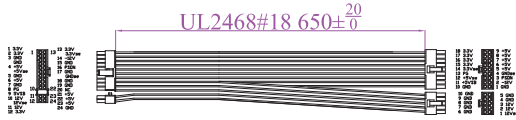

PB

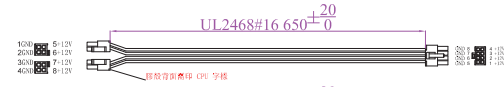

PC

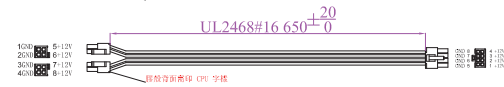

PD

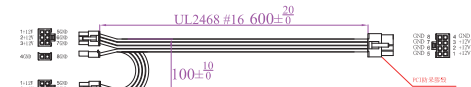

PD1

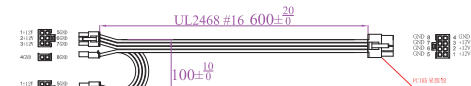

P1

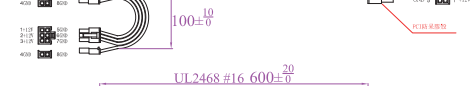

PD

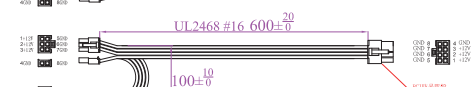

P1

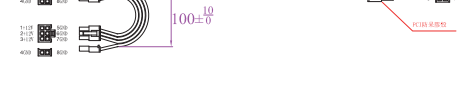

PD

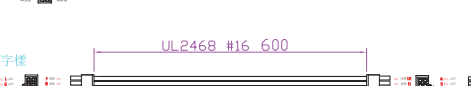

PE

印白色600W字樣

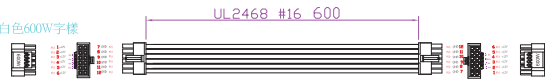

PF

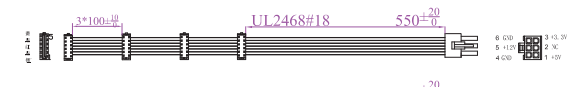

PF

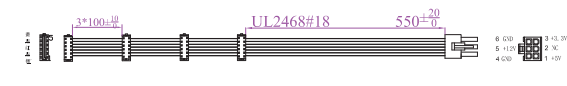

PF

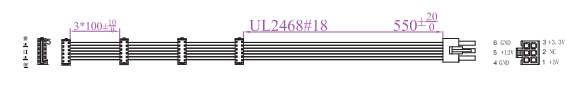

PG

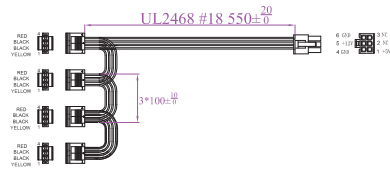

PH

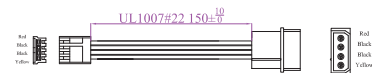

絲印顏色:
PANTONE 877C (消銀)

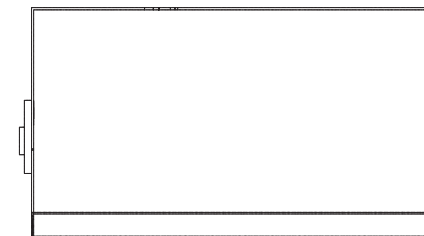
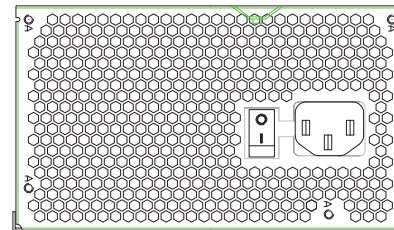
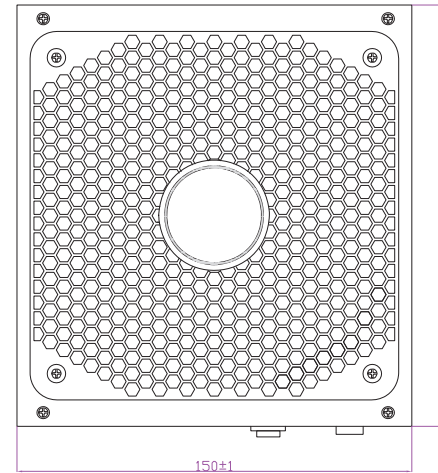
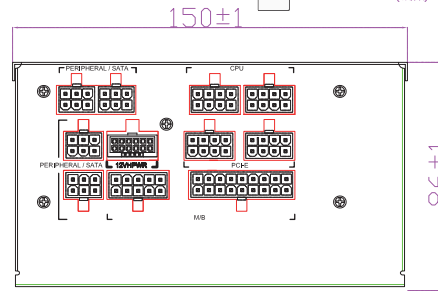

REF.ID.	PIN NO.	COLOR	V
PA	1	ORANGE	+3.3V
	2	ORANGE	+3.3V
	3	BLACK	COM
	4	RED	+5V
	5	BLACK	COM
	6	RED	+5V
	7	BLACK	COM
	8	GRAY	PWR_OK
	9	PURPLE	+5VSB
	10	YELLOW	+12V
	11	YELLOW	+12V
	12	ORANGE	+3.3V
		ORANGE	+3.3V
	13	BROWN	+3.3V(SMB)
	14	BLUE	-12V
	15	BLACK	COM
	16	GREEN	PS_ON#
	17	BLACK	COM
	18	BLACK	COM
	19	BLACK	COM
	20		
	21	RED	+5V
	22	RED	+5V
	23	RED	+5V
24	BLACK	COM	
PH	1	RED	+5V
	2	BLACK	COM
	3	BLACK	COM
	4	YELLOW	+12V

REF.ID.	PIN NO.	COLOR	V
PF	1	ORANGE	+3.3V
	2	BLACK	COM
	3	RED	+5V
	4	BLACK	COM
	5	YELLOW	+12V
PG	1	YELLOW	+12V
	2	BLACK	COM
	3	BLACK	COM
	4	RED	+5V
PB PC	1	BLACK	COM
	2	BLACK	COM
	3	BLACK	COM
	4	BLACK	COM
	5	YELLOW	+12V
	6	YELLOW	+12V
	7	YELLOW	+12V
	8	YELLOW	+12V
PD- PD1	1	YELLOW	+12V
	2	YELLOW	+12V
	3	YELLOW	+12V
	4	BLACK	COM
	5	BLACK	COM
	6	BLACK	COM
	7	BLACK	COM
	8	BLACK	COM
PE	1	YELLOW	+12V
	2	YELLOW	+12V
	3	YELLOW	+12V
	4	YELLOW	+12V
	5	YELLOW	+12V
	6	YELLOW	+12V
	7	BLACK	COM
	8	BLACK	COM
	9	BLACK	COM
	10	BLACK	COM
	11	BLACK	COM
	12	BLACK	COM
1	BLACK	S1	
2	BLACK	S2	
3	BLACK	S3	
4	BLACK	S4	



HIGH POWER ELECTRONIC CO., LTD.